

Pega 358s Layout Drawings



Amada America Inc.
7025 Firestone Blvd.
Buena Park CA. 90621
Phone: (714) 739 2111
Fax.: (714) 739 4099
Email info@amada.com

Contents

- Planning the Location of the Machine 3
 - Lifting the Machine..... 4
 - Machine Dimensions - Plan View 5
 - Machine Dimensions - End View 6
 - Machine Dimensions - Elevation View..... 7
 - Maintenance Areas..... 8

- Foundation Requirements..... 9
 - Foundation J-bolt Detail..... 10
 - Foundation Plan View..... 11
 - Foundation Elevation View 12

Planning the Location of the Machine

The following diagrams provide the details for positioning your new machine.

- No obstacles are allowed in the worksheet travel area and the ceiling must be at least 40" above the top of the Pega 358s.
- All of the maintenance areas recommended should be used, but you must at least ensure that the doors of the Fanuc O4PC NC unit can be opened.
- The Pega 358s and Fanuc O4PC control must be protected from direct sunlight or other heat sources. It has been shown that radiant type heaters can cause serious tool alignment problems.

Lifting the Machine

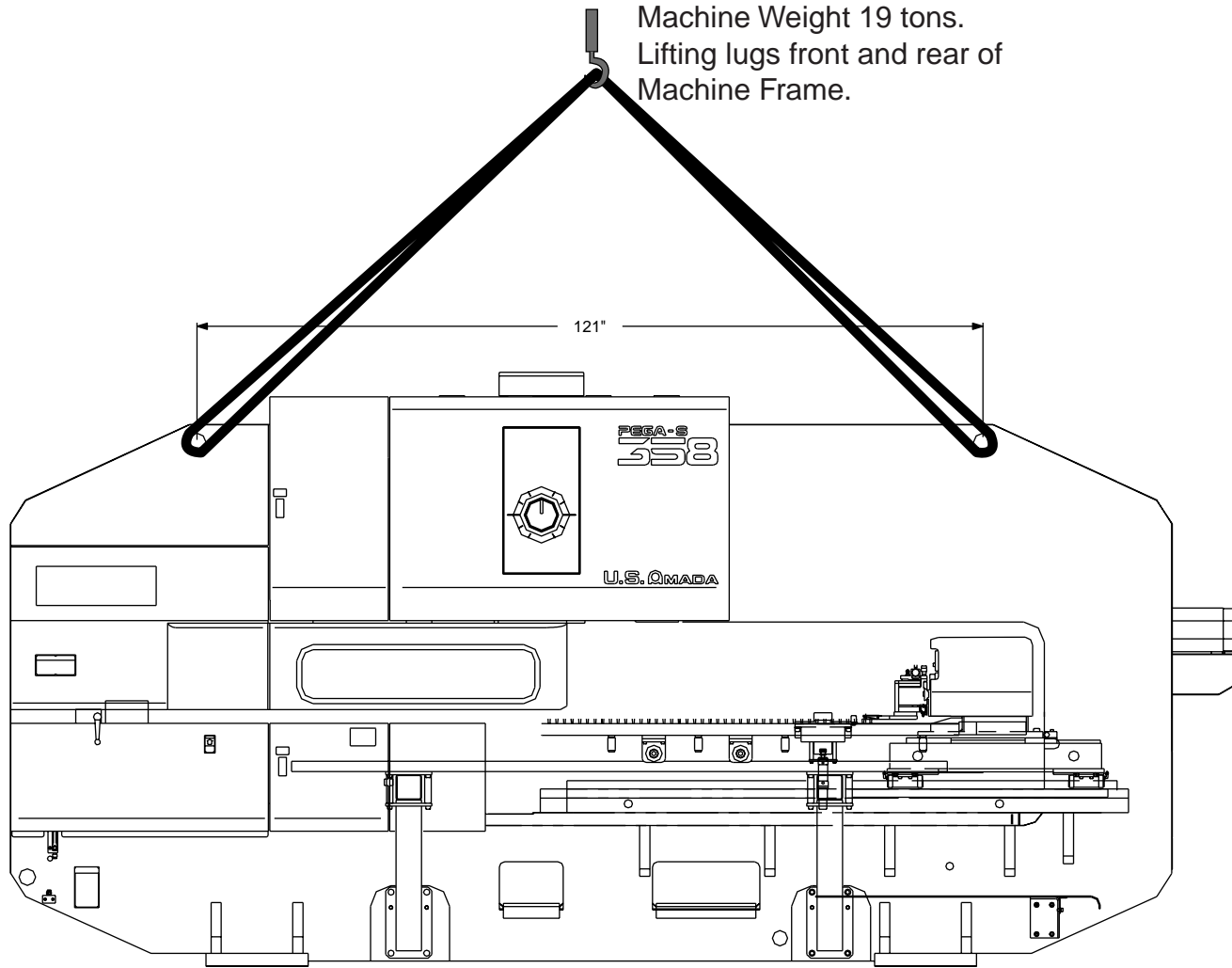

Machine Weight 19 tons.
Lifting lugs front and rear of
Machine Frame.

121"

Machine Dimensions - Plan View

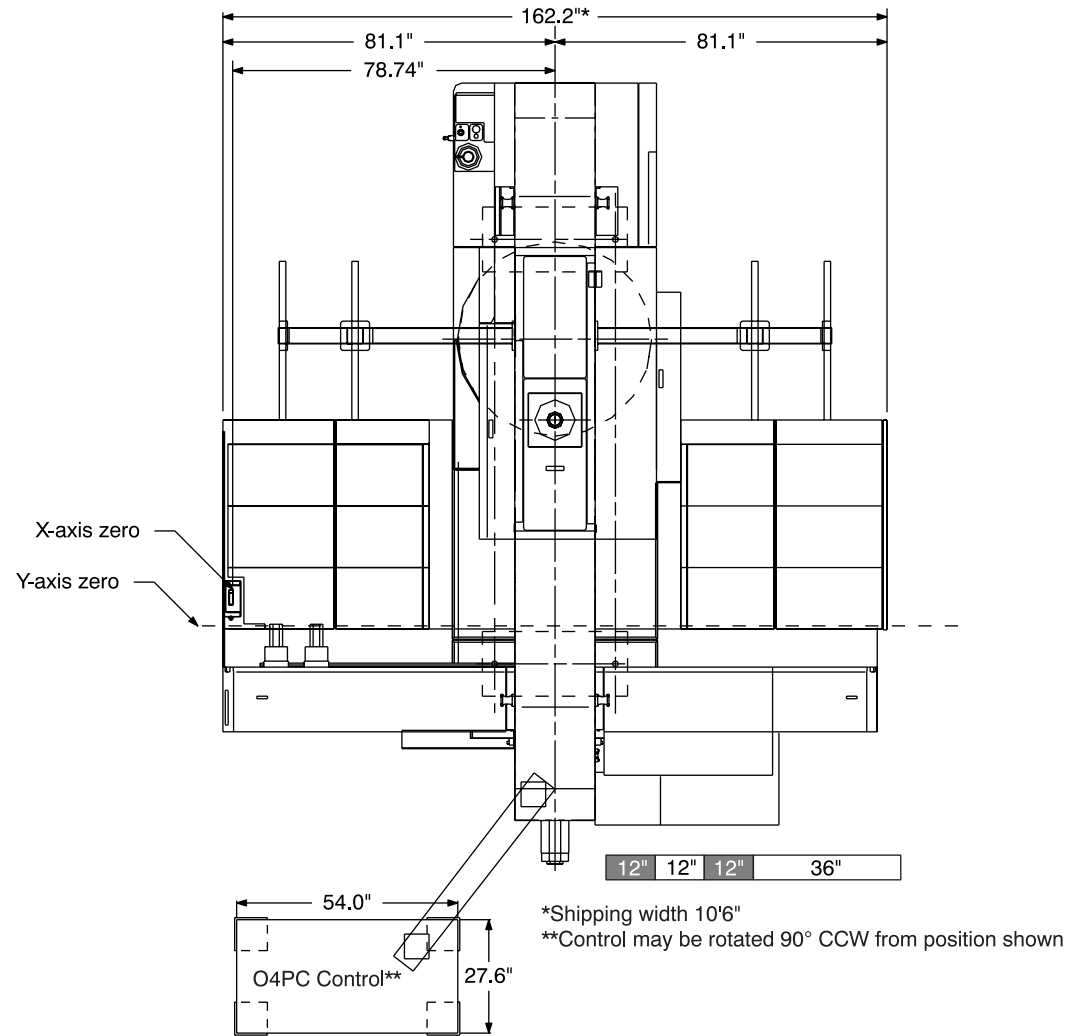

Machine Dimensions - End View

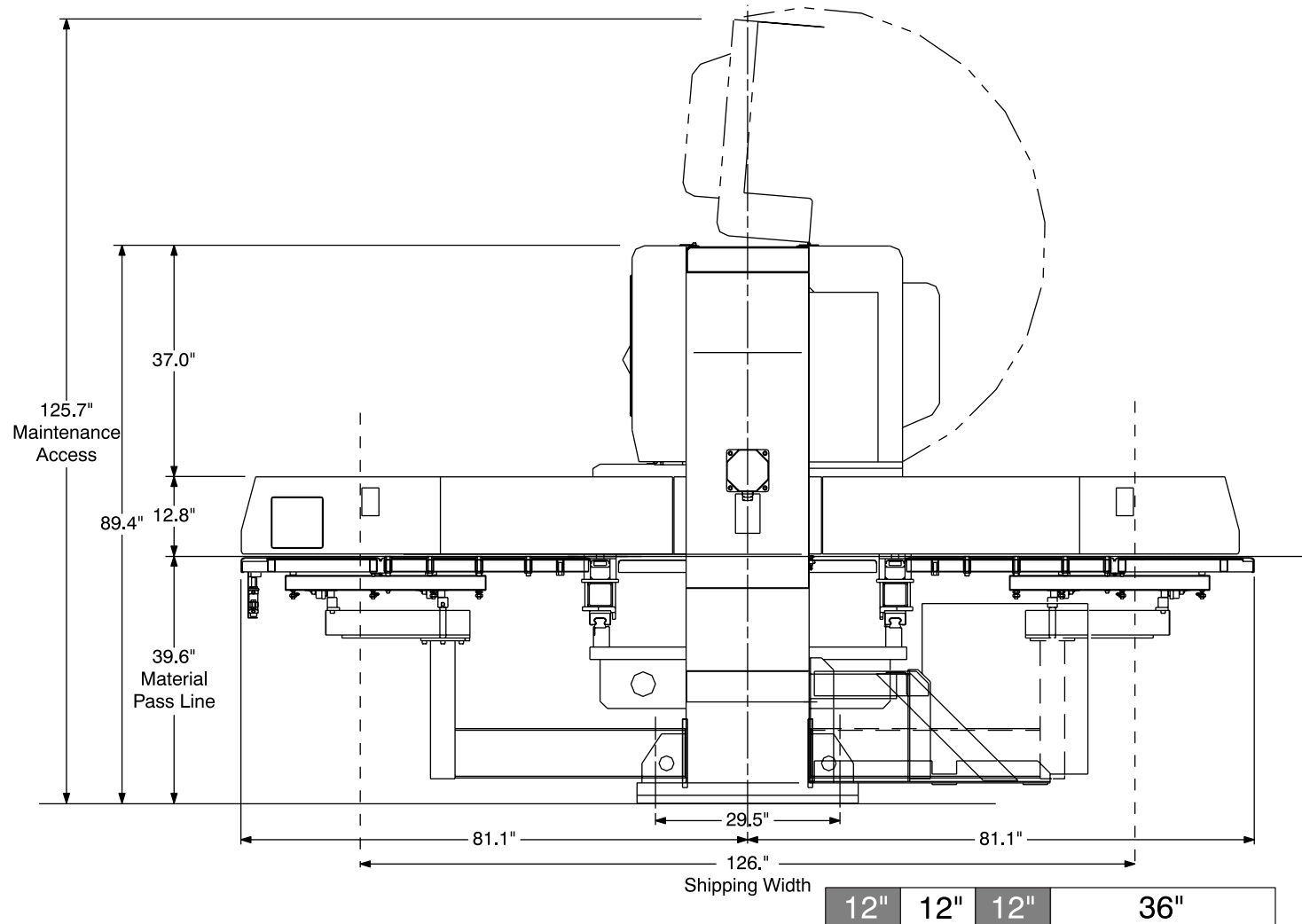

Machine Dimensions - Elevation View

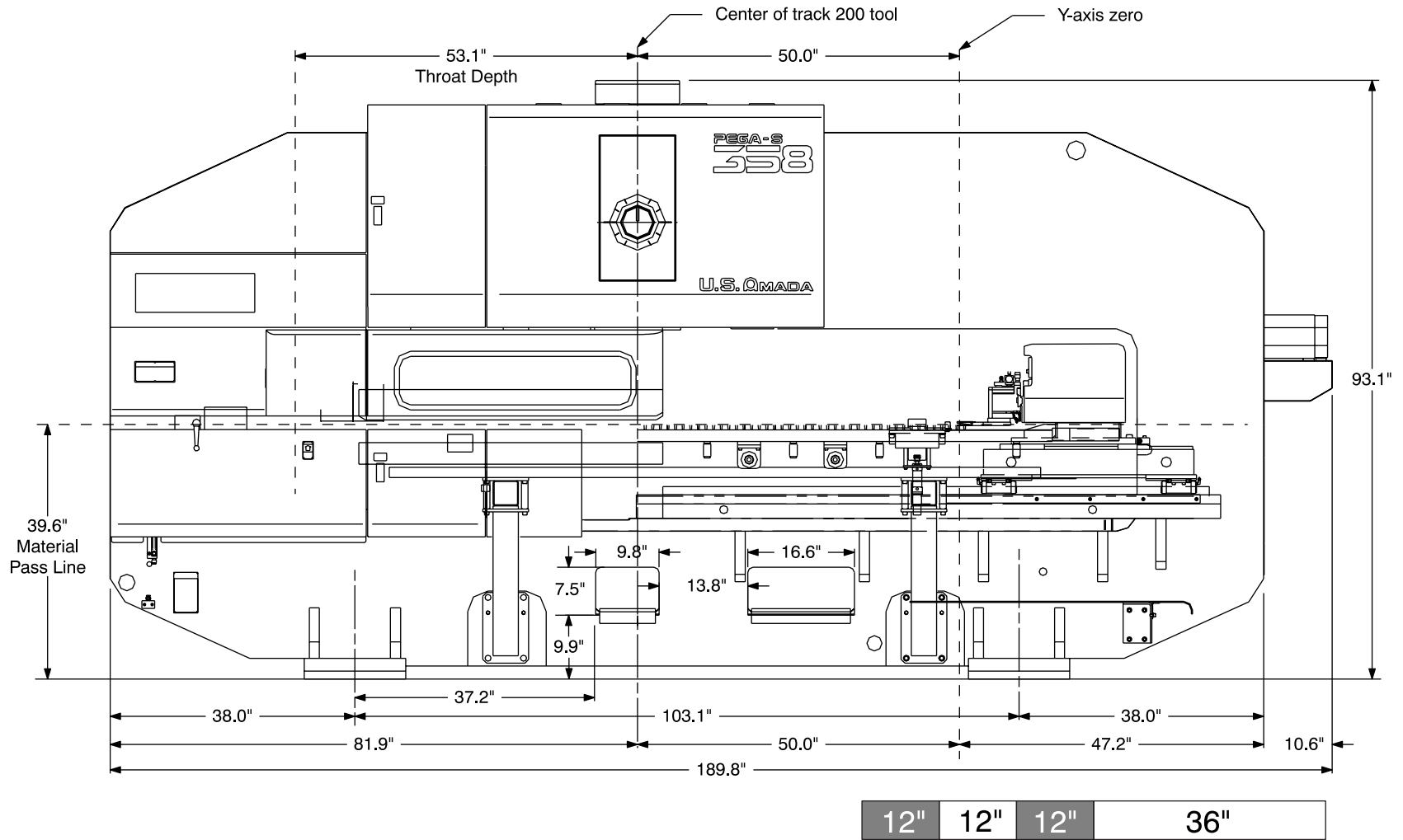

Maintenance Areas

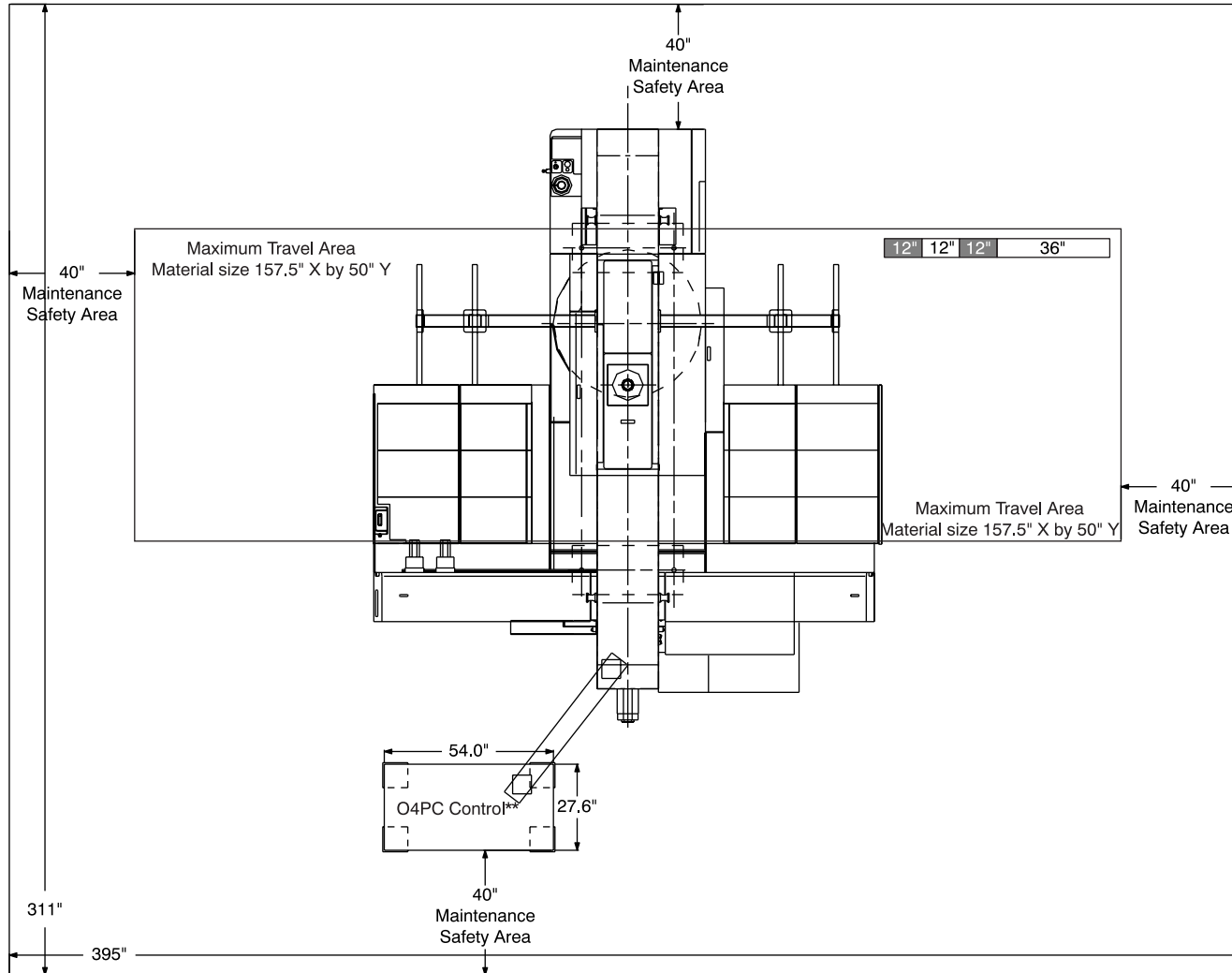

Foundation Requirements

The Pega 358s does not require a special foundation to perform as expected, however there are minimum requirements that an existing floor must meet in order to assure machine reliability and tool life. If the existing floor does not meet the following minimum requirements, plans for a recommended foundation are given in this document.

The minimum acceptable floor conditions to assure a successful installation are:

- The area of the floor where the machine frame is to be located must be a single, homogeneous slab in good condition. There must be no cracks or other signs of deterioration of the floor.
- The floor must be 4" to 6" thick.
- The floor must be capable of supporting 3.5 tons/ft².
- The floor must be level to 0.032"/ft.

If the existing floor meets the minimum requirement list above, it must still be inspected carefully when the anchor-bolt holes are cut. Voids under the floor, or wetness (not associated with the hole cutting procedure) should be considered signs of an inadequate floor and a new machine location or new foundation must be considered.

It is the customer's responsibility to determine that the floor meets these minimum requirements. Placing the machine on an inadequate, cracked floor, or straddling seams in a floor may be grounds for voiding the machine warranty!

Amada America, Inc. does not recommend the use of vibration isolating mounts under the machine feet, as these devices have been shown to increase the vibration within the machine frame, increasing the likelihood of vibration related problems. Solid leveling devices are acceptable provided they incorporate a means of anchoring the machine to the floor with the supplied J-bolts.

Foundation J-bolt Detail

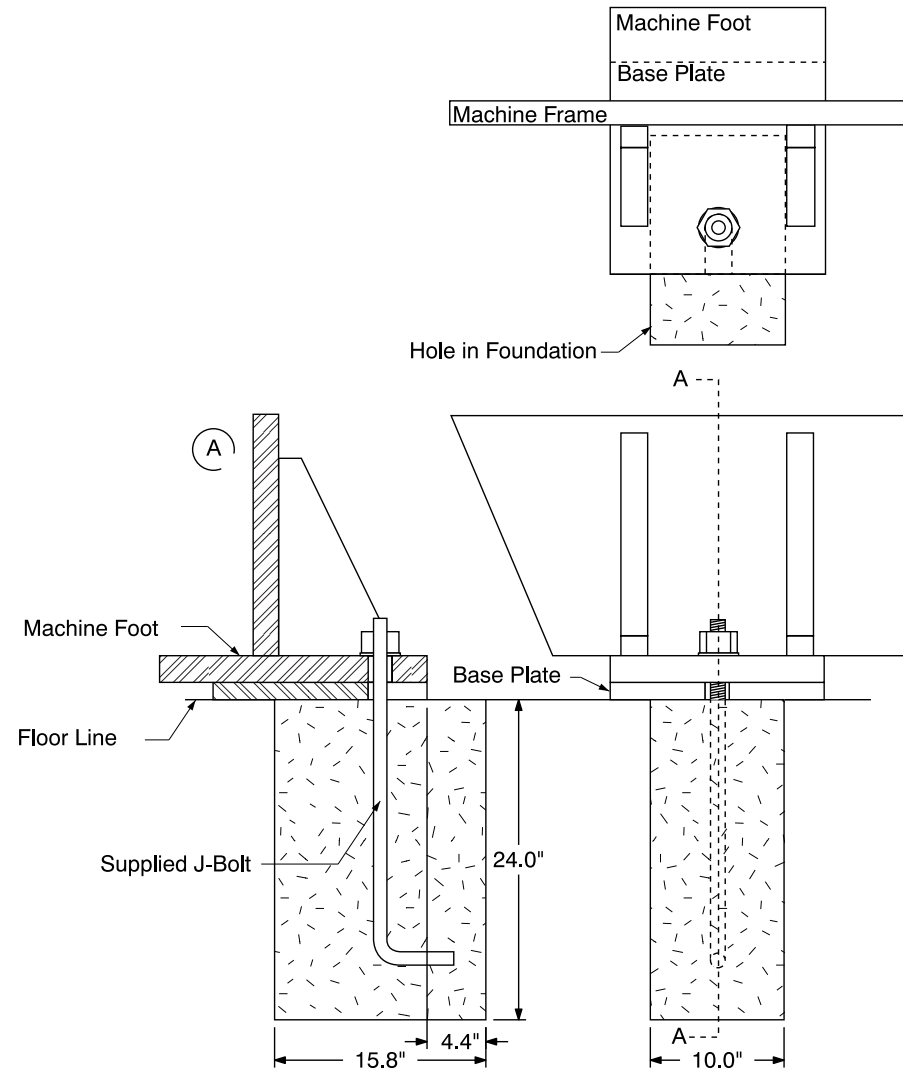

Foundation Plan View

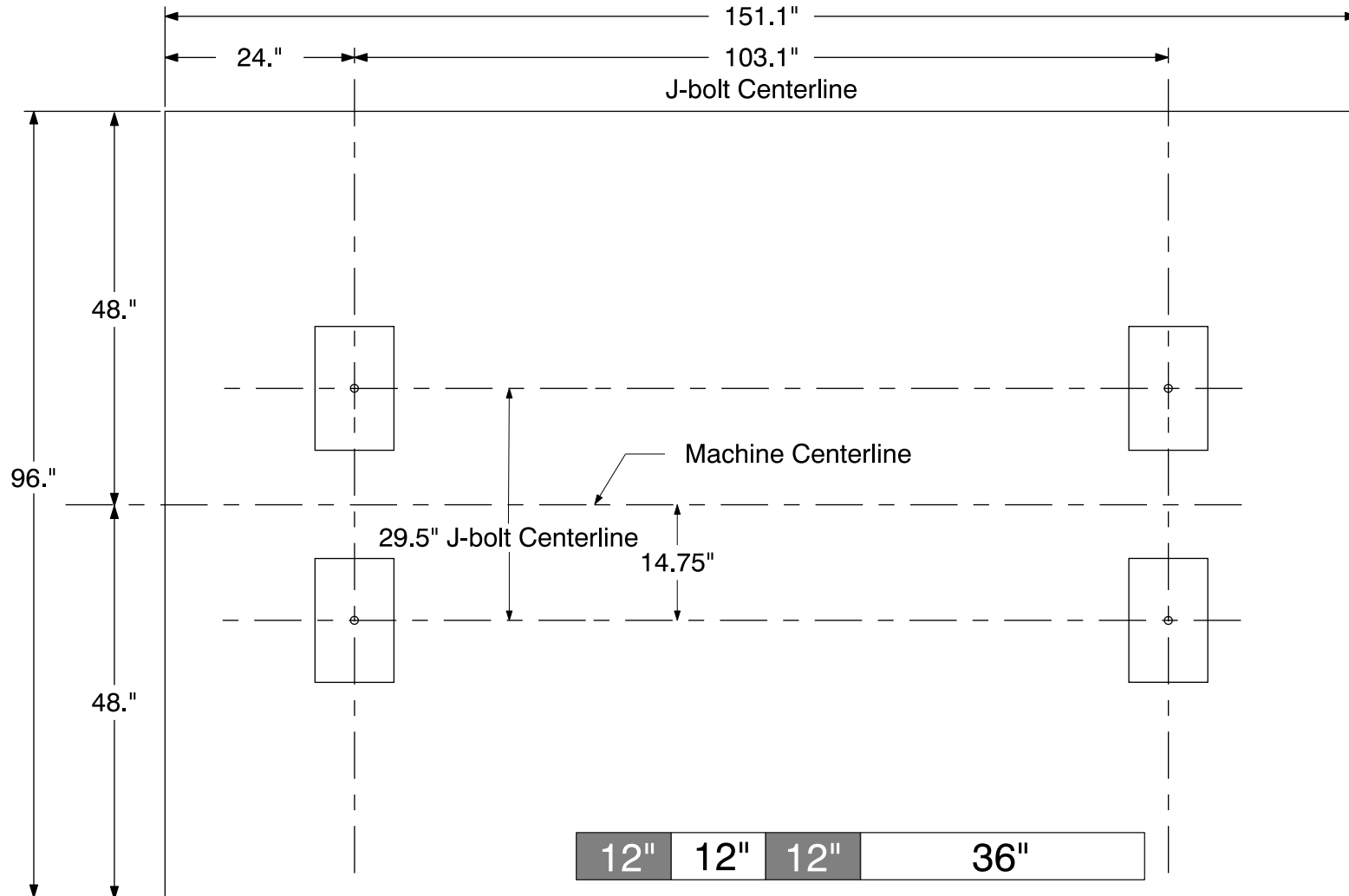

Foundation Elevation View

