

FANUC 18P Communications

**For Machine Models
Vipros 255, Pega 255, Vipros 2510 King
Vipros 358 King Type II, Vipros 368 King Type II
Vipros 357 Queen, Vipros 367 Queen**



**LAPIS SERVICES
(219) 464-9131**

**Amada Support,
Rebuilds, Sales And
Fanuc Control Upgrade**

Amada America, Inc.
7025 Firestone Blvd.
Buena Park, CA 90621
Phone: 714-739-2111
Fax: 714-739-4099
e-mail: info@amada.com

Contents

Setting I/O channel for floppy disk or RS-232 communication.3

Transferring a Program to Control Memory from Floppy Disk.....4

Transferring a Program to Control Memory from a PC.....5

Transferring a Program to Control Memory from a PC using Windows9x/2000 HyperTerminal* Program.6

Transferring a Program from Control Memory to a Floppy Disk9

Transferring a Program from Control Memory to a PC using RS-232 connection.....10

Transferring a Program from Control Memory to a PC using Windows9x/2000 HyperTerminal Program.....11

Configuring Parameters for RS 232 Communication13

Configuring Parameters to Communicate with the Internal Floppy Disk15

Configuring Windows9x/2000 HyperTerminal Program to Communicate with the Fanuc 18P Control.17

Fanuc 18P Control Floppy Scheduler Operation.....20

Communications Block Diagram22

Cables23







LAPIS SERVICES
(219) 464-9131

**Amada Support,
 Rebuilds, Sales And
 Fanuc Control Upgrades.**

Setting I/O channel for floppy disk or RS-232 communication.

Before attempting transfer of programs to/from the control, please confirm that the appropriate I/O channel has been selected in the Fanuc 18 P control.

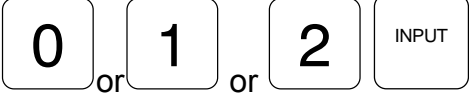
Switch the <i>EDIT PROTECT</i> Key-switch to the OFF position.	
Press <i>MDI Mode</i> pushbutton.	
Press the <i>SET</i> pushbutton.	
Press <i>SETTING</i> softkey.	
Press <i>UP</i> pushbutton or <i>DOWN</i> pushbutton to highlight <i>I/O CHANNEL</i> .	
Change <i>I/O CHANNEL</i> value to 0, 1 or 2 by pressing the <i>NUMBER 0</i> (or 1 or 2) pushbutton and then the <i>INPUT</i> pushbutton. (see table below)	

Use the values in the following table to determine the correct I/O Channel setting.

Machine Model	RS-232:	Floppy Disk:
Vipros 255	1	0
Vipros 2510 King	1	0
Vipros 558 King Type II	1	0
Vipros 368 King Type II	1	0
Vipros 357 Queen	2	0
Vipros 367 Queen	2	0
Pega 255	1	0

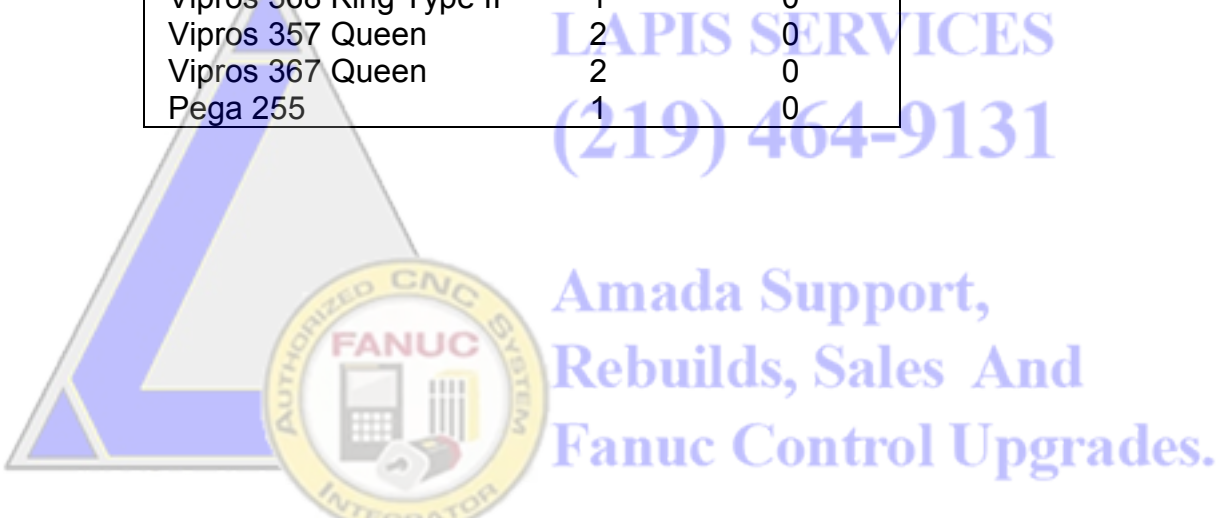









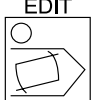

LAPIS SERVICES
(219) 464-9131
Amada Support,
Rebuilds, Sales And
Fanuc Control Upgrades.

Transferring a Program to Control Memory from Floppy Disk

This procedure is used to transfer a G-code part program to the Fanuc 18P Control memory from a floppy disk. Before beginning, check that the communication parameters are set as described in the section "Configuring Parameters to Communicate with Internal Floppy Disk" on page 15 of this document. Set correct I/O setting as instructed in the first section of this document.

At the Fanuc 18P Control:

Place floppy disk in floppy drive and close door (door must be closed!).	
Turn <i>EDIT PROTECT</i> Key switch to the OFF position.	
Press the <i>EDIT</i> mode switch	
Press <i>PROG</i> pushbutton.	
Press the + <i>NEXT MENU</i> softkey.	
Press the <i>FLOPPY</i> softkey.	
Press the <i>PAGE UP ARROW</i> pushbutton.	
Press the (<i>OPRT</i>) softkey.	
Press the <i>READ</i> softkey.	
Enter the displayed file number that you wish to load, and press the <i>F SET</i> softkey.	
If the part program does not contain an "O" Number in the G-code, enter a four-digit number and press the <i>O SET</i> softkey.	
Press the <i>EXEC</i> softkey.	
If there is not a "%" at the end of the actual G-code program it will be necessary to press the <i>STOP</i> softkey to end the transmission.	

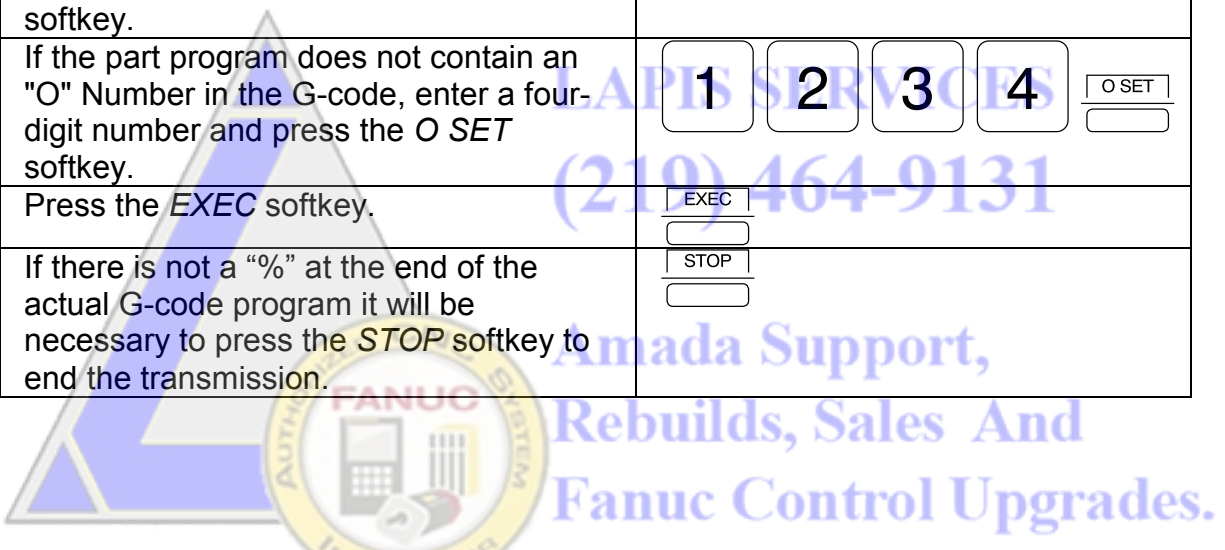







Transferring a Program to Control Memory from a PC

The following conditions must exist to use this procedure:

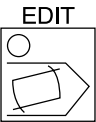
Check that the communication parameters are set as described in the section "*Configuring Parameters for RS 232 Communication*"

Connect the PC communications port to the Fanuc 18P Control RS232 Port. See the section "*Cables*" (page 23) of this document for correct cable configuration.

At the Fanuc 18P Control:

Set correct I/O setting as instructed in the first section of this document.	 SET
Press the <i>EDIT</i> mode switch	
Press the <i>PROG</i> pushbutton	
Press the <i>DIR</i> softkey	
Confirm that none of the part program numbers (i.e."O1234") that are to be downloaded currently exist in the Fanuc 18P Control memory.	
Press the (<i>OPRT</i>) softkey	
Press the + <i>NEXT MENU</i> softkey	
Press the <i>EXEC</i> softkey	
When communications are finished the control will display the downloaded program.	
If the downloaded program does not contain a "%" sign as the last line of the G-code it will be necessary to press the <i>STOP</i> button to end communications.	

LAPIS SERVICES
(219) 464-9131

Amada Support,
Rebuilds, Sales And
Fanuc Control Upgrades.



Transferring a Program to Control Memory from a PC using Windows9x/2000 HyperTerminal* Program.

This procedure is used to transfer a G-code part program to the Fanuc 18P Control memory from a PC using the Windows HyperTerminal program. HyperTerminal is included with Windows 9x/2000 and can be found in the "Accessories/communications" category. If it does not appear there, it may be necessary to install it from the original Windows installation disks.

The following conditions must exist to use this procedure:

Connect the communications cable between the computer and the Fanuc 18P Control RS232 connector. See the section "*Cables*" (page 23) of this document for correct cable configuration.

Use the "Amada standard RS232 Cable" configuration.

Configure the Fanuc 18P Control communication parameters for RS 232 Communication See the section "*Configuring Parameters for RS 232 Communication*".

Configure the Windows9x/2000 HyperTerminal program to communicate with the Fanuc 18P Control. See the section *Configuring Windows HyperTerminal Program to Communicate with the Fanuc 18P Control* (page 17) of this document.

***NOTE: Windows HyperTerminal is known to have problems and in some circumstances may not work correctly. It is recommended that a newer version be installed if any problems are encountered. A free upgrade can be downloaded from this site: <http://www.hilgraeve.com/hpte/download.html> The newer version is known as "HyperTerminal Private edition".**

At the PC:

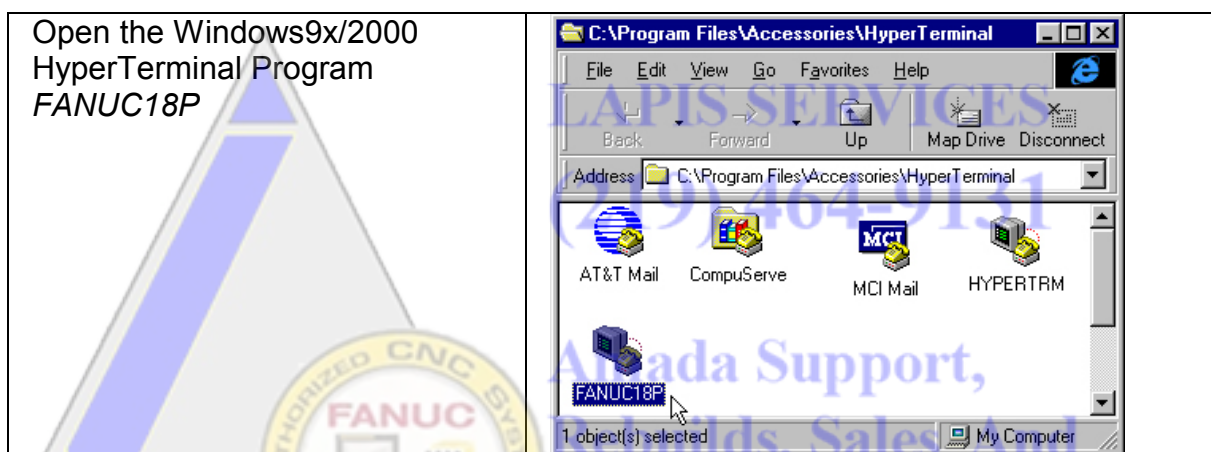

Select a file to send to the Fanuc 18P Control by:
 Select: Transfer
 Send Text File

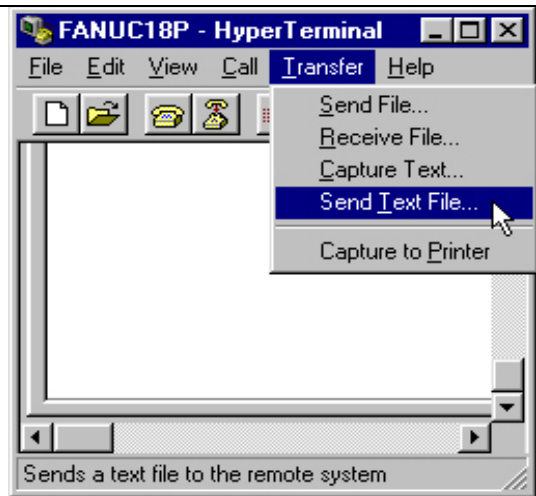

At the 18P control: Prepare the control to receive the program as directed in the section on "Transferring a program to control memory from a PC".

Select the Drive, Directory, and File to download to the Fanuc 18P Control.
 Select *Open* to download the file.

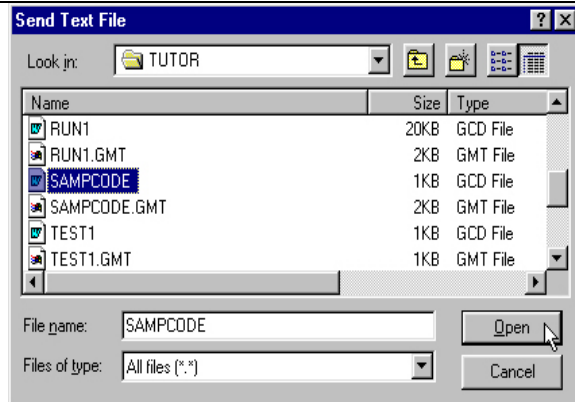

The part program will scroll across the screen until transmission is complete.

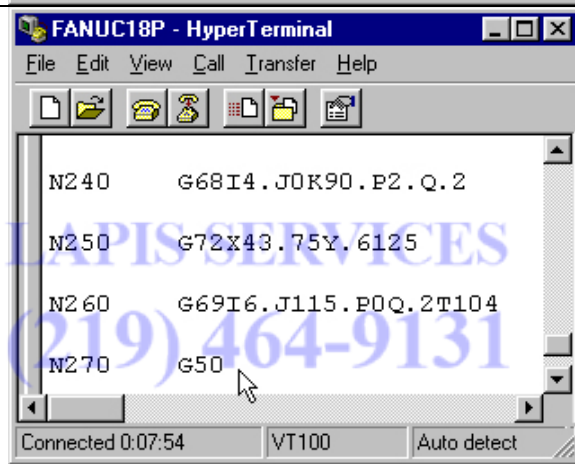

Amada Support,
 Rebuilds, Sales And
 Fanuc Control Upgrades.

Stop the transmission sequence by:
 Select Call
 Disconnect

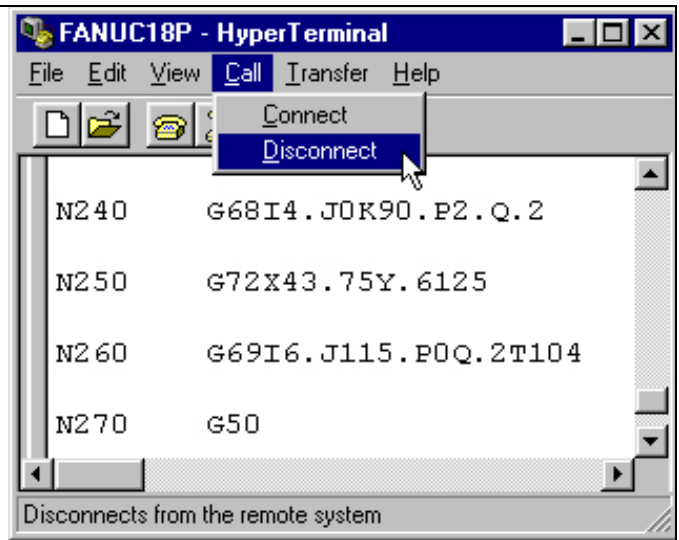

At the Fanuc 18P Control:

When the Transmission is complete the downloaded program will be displayed.	
---	--



LAPIS SERVICES
(219) 464-9131











**Amada Support,
 Rebuilds, Sales And
 Fanuc Control Upgrades.**

Transferring a Program from Control Memory to a Floppy Disk

This procedure is used to transfer a G-code program from the Fanuc 18P Control memory to a floppy disk.

Check that the communication parameters are set as described in the section "Configuring Parameters to Communicate with Internal Floppy Disk" (page 15) of this document.

At the Fanuc 18P Control:

Set correct I/O setting as instructed in the first section of this document.	
Place floppy disk in floppy drive and close door.	
Set <i>FD / EXTERNAL</i> switch to FD.	
Turn <i>EDIT PROTECT</i> Key switch to the OFF position.	
Press <i>EDIT MODE</i> pushbutton.	
Press <i>PROG</i> pushbutton.	
Press <i>DIR</i> softkey.	
Press (<i>OPRT</i>) softkey.	
Press the letter "O" and the four-digit part program number to transfer.	 and the four-digit part program number
Press the + <i>NEXT MENU</i> softkey.	
Press the <i>PUNCH</i> softkey.	
Press the <i>EXEC</i> softkey.	

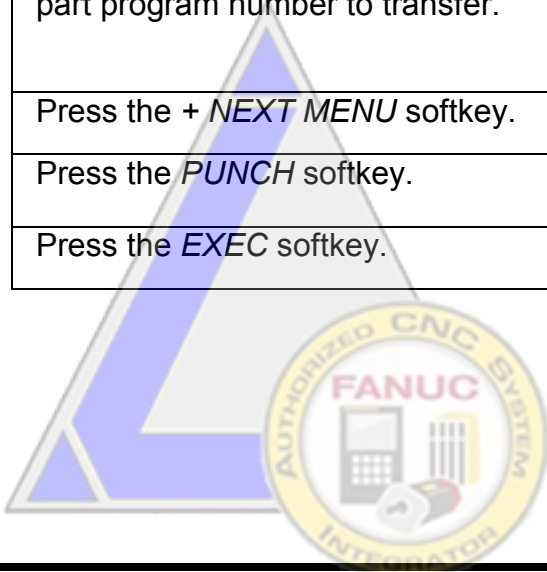

Amada Support,
Rebuilds, Sales And
Fanuc Control Upgrades.









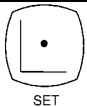

Transferring a Program from Control Memory to a PC using RS-232 connection.

This procedure is used to transfer a G-code part program from the Fanuc 18P Control memory to a PC using the RS-232 connection and suitable communication software.

Check that the communication parameters are set as described in the section "Configuring parameters for RS-232 communication".

Connect the PC communications port to the Machine RS232 Port. See the section "Cables" (page 23) of this document for correct cable configuration.

At the Fanuc 18P Control:

Set correct I/O setting as instructed in the first section of this document.	
Switch <i>FD / EXTERNAL</i> switch to <u>External</u> .	
Turn <i>EDIT PROTECT</i> Key switch to the OFF position.	
Press the <i>EDIT</i> Mode pushbutton	
Press the <i>PROG</i> pushbutton	
Press the <i>DIR</i> softkey	
Press the (<i>OPRT</i>) softkey	
Press the + <i>NEXT MENU</i> softkey	
Type the letter "O" and the four-digit part program number as displayed in the directory listing	
Prepare the communication software on the PC to receive the program. (Refer to documentation supplied with the communication software)	
Press the <i>PUNCH</i> softkey	
Press the <i>EXEC</i> softkey	

Transferring a Program from Control Memory to a PC using Windows9x/2000 HyperTerminal Program

This procedure is used to transfer a G-code part program from the Fanuc 18P Control memory to a PC using the Windows9x/2000 HyperTerminal program.

Connect the communications cable between the computer and the RS232 connector on the Fanuc 18P Control.

See the section "Cables" (page 23) of this document for correct cable configuration. Use the "Amada standard RS232 Cable" configuration.

Configure the Fanuc 18P Control communication parameters. See the section "Configuring Parameters for RS-232".

Configure the Windows9x/2000 HyperTerminal program to communicate with the Fanuc 18P Control. See the section Configuring Windows HyperTerminal Program to Communicate with the Fanuc 18P Control (page 17) of this document.

***NOTE: Windows HyperTerminal is known to have problems and in some circumstances may not work correctly. It is recommended that a newer version be installed if any problems are encountered. A free upgrade can be downloaded from this site: <http://www.hilgraeve.com/hpte/download.html> The newer version is known as "HyperTerminal Private edition".**

At the PC:

Open the Windows9x/2000 HyperTerminal Program *FANUC18P*.

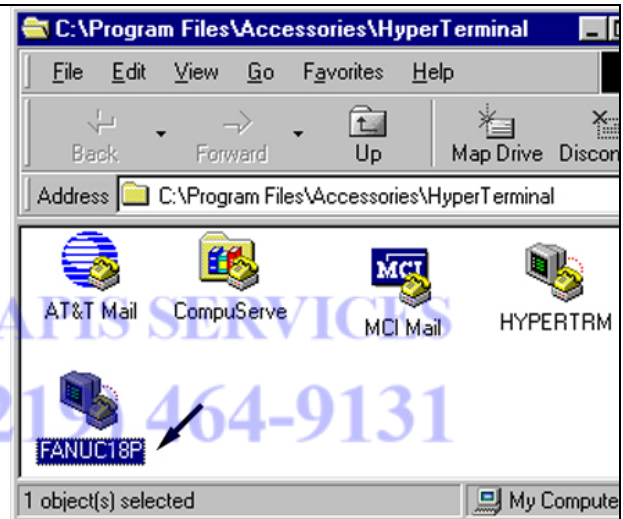

Amada Support,
Rebuilds, Sales And
Fanuc Control Upgrades.

To receive a file from the Fanuc 18P Control:
 Select: Transfer
 Capture Text

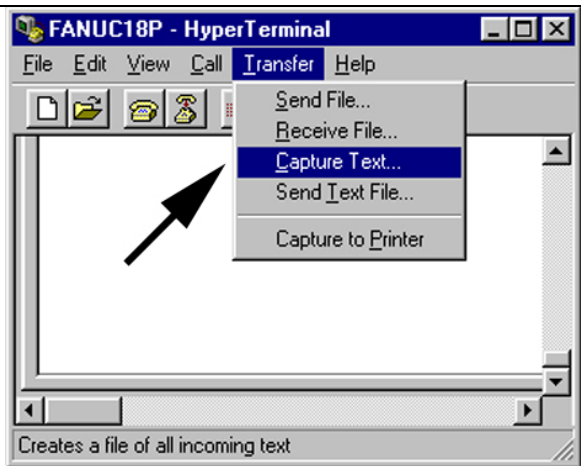

Enter the part program file path and name.
 Select *Start* to begin reception.

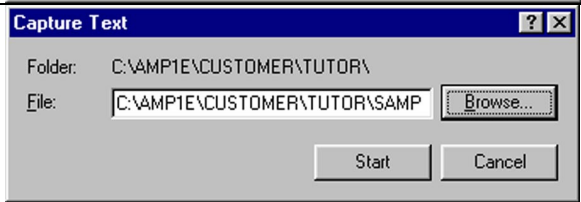

At the Control: Begin sending the program to the computer. See section on "Transferring a Program from Control Memory to a PC using RS-232 connection."

The part program will scroll across the screen until transmission is complete.

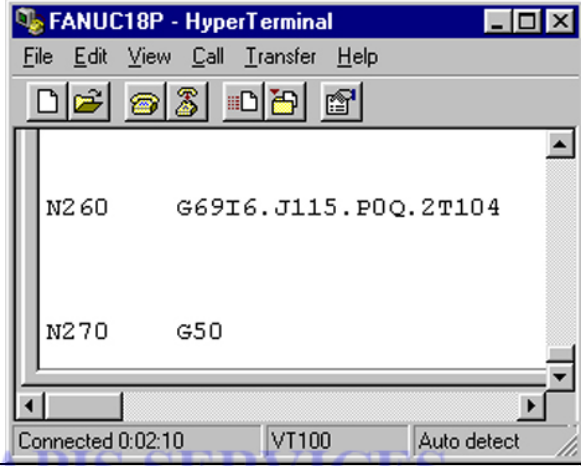



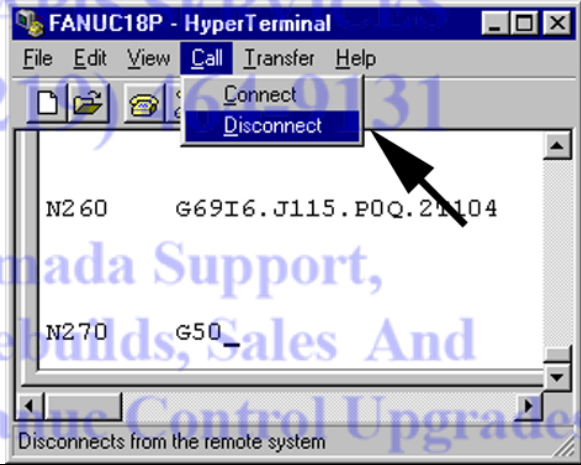









Stop the transmission sequence by:
 Select: Call
 Disconnect



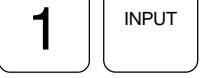







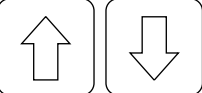

Configuring Parameters for RS 232 Communication

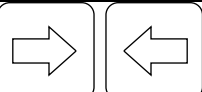
This procedure configures the Fanuc 18P Control to communicate through the RS-232 connection using a communication software application..

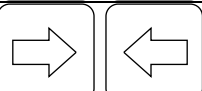
At the Fanuc 18P Control:

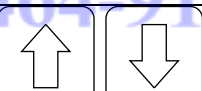







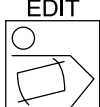

<p>Press <i>MDI</i> Mode pushbutton.</p>	
<p>Turn <i>EDIT PROTECT</i> Key switch to the OFF position.</p>	
<p>Press the <i>SET</i> pushbutton.</p>	
<p>Press <i>SETTING</i> softkey.</p>	
<p>Press <i>PAGE UP</i> pushbutton or <i>PAGE DOWN</i> pushbutton until display changes to read <i>SETTING (HANDY)</i>.</p>	
<p>Press <i>UP</i> pushbutton or <i>DOWN</i> pushbutton to highlight <i>PARAMETER WRITE</i>.</p>	
<p>Change <i>PARAMETER WRITE</i> value to 1 by pressing the <i>NUMBER 1</i> pushbutton and then the <i>INPUT</i> pushbutton. An alarm will be generated at this point. Ignore the alarm, but be careful not to alter any parameters other than what is described here.</p>	
<p>Press <i>OFFSET SETTING</i> pushbutton.</p>	
<p>Press <i>SYSTEM</i> pushbutton.</p>	
<p>Press <i>PARAM</i> softkey.</p>	
<p>Press <i>PAGE UP</i> pushbutton or <i>PAGE DOWN</i> pushbutton until display reads <i>PARAMETER (RS232C INTERFACE)</i>.</p>	
<p>Press the <i>UP</i> pushbutton or <i>DOWN</i> pushbutton to highlight parameter 0100.</p>	
<p>Set the parameter to value 00001000 by pressing the <i>RIGHT</i> or <i>LEFT</i> pushbutton to highlight the individual parameter bit and pressing the correct numeral pushbutton to</p>	





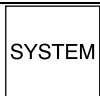
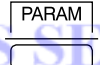





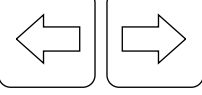

change the value. Press the <i>INPUT</i> pushbutton.	
Press the <i>UP</i> pushbutton or <i>DOWN</i> pushbutton to highlight parameter 0111.	
Set the parameter to value 10000001 by pressing the <i>RIGHT</i> or <i>LEFT</i> pushbutton to highlight the individual parameter bit and pressing the correct numeral pushbutton to change the value.	
Press the <i>INPUT</i> pushbutton.	
Press the <i>UP</i> pushbutton or <i>DOWN</i> pushbutton to highlight parameter 0112.	
Set the <i>DEVICE NUM</i> parameter to value 0 by pressing the <i>RIGHT</i> or <i>LEFT</i> pushbutton to highlight the parameter bit and pressing the correct numeral pushbutton to change the value.	
Press the <i>INPUT</i> pushbutton.	
Press the <i>UP</i> pushbutton or <i>DOWN</i> pushbutton to highlight parameter 0113.	
Set the <i>BAUDRATE (CH1)</i> parameter to correct value by pressing the <i>RIGHT</i> or <i>LEFT</i> pushbutton to highlight the parameter bit and pressing the correct numeral pushbutton to change the parameter value. See page 22 for baud rate settings.	
Press the <i>INPUT</i> pushbutton.	
Press <i>SET</i> pushbutton.	
Press <i>UP</i> pushbutton or <i>DOWN</i> pushbutton to highlight <i>PARAMETER WRITE</i> .	
Change <i>PARAMETER WRITE</i> value to 0 by pressing the number 0 pushbutton and then the <i>INPUT</i> pushbutton.	
Press the <i>RESET</i> pushbutton to reset ALARM 100.	

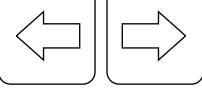
Configuring Parameters to Communicate with the Internal Floppy Disk

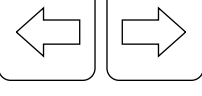
This procedure is used to configure the Fanuc 18P Control to communicate with the internal floppy disk drive.

At the Fanuc 18P Control:

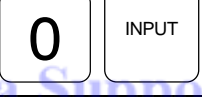
Press <i>MDI Mode</i> pushbutton.	
Turn <i>EDIT PROTECT</i> Key switch to the OFF position.	
Press <i>OFFSET SETTING</i> pushbutton.	
Press <i>SETTING</i> softkey.	
Press <i>PAGE UP</i> pushbutton or <i>PAGE DOWN</i> pushbutton until display changes to read <i>SETTING (HANDY)</i> .	
Press <i>UP</i> pushbutton or <i>DOWN</i> pushbutton to highlight <i>PARAMETER WRITE</i> .	
Change <i>PARAMETER WRITE</i> value to 1 by pressing the <i>NUMBER 1</i> pushbutton and then the <i>INPUT</i> pushbutton. An alarm will be generated at this point. Ignore the alarm, but be careful not to alter any parameters other than what is described here.	
Press <i>SYSTEM</i> pushbutton.	
Press <i>PARAM</i> softkey.	
Press <i>PAGE UP</i> pushbutton or <i>PAGE DOWN</i> pushbutton until display reads <i>PARAMETER (RS232C INTERFACE)</i> .	
Press the <i>UP</i> pushbutton or <i>DOWN</i> pushbutton to highlight parameter 0100.	
Set the parameter to value 00001000 by pressing the <i>RIGHT</i> or <i>LEFT</i> pushbutton to highlight the individual parameter bit and pressing the correct numeral pushbutton to change the value.	

Press the <i>INPUT</i> pushbutton.	
Press the <i>UP</i> pushbutton or <i>DOWN</i> pushbutton to highlight parameter 0101.	
Set the parameter to value 10001001 by pressing the <i>RIGHT</i> or <i>LEFT</i> pushbutton to highlight the individual parameter bit and pressing the correct numeral pushbutton to change the value.	
Press the <i>INPUT</i> pushbutton.	
Press the <i>UP</i> pushbutton or <i>DOWN</i> pushbutton to highlight parameter 0102.	
Set the <i>DEVICE NUM</i> parameter to value 3 by pressing the <i>RIGHT</i> or <i>LEFT</i> pushbutton to highlight the individual parameter bit and pressing the correct numeral pushbutton to change the value.	
Press the <i>INPUT</i> pushbutton.	
Press the <i>UP</i> pushbutton or <i>DOWN</i> pushbutton to highlight parameter 0103.	
Set the <i>BAUDRATE</i> parameter to value 10 by pressing the <i>RIGHT</i> or <i>LEFT</i> pushbutton to highlight the individual parameter bit and pressing the correct numeral pushbutton to change the value.	
Press the <i>INPUT</i> pushbutton.	
Press <i>OFFSET SETTING</i> pushbutton. Display will change to read <i>SETTING (HANDY)</i> .	
Press <i>UP</i> pushbutton or <i>DOWN</i> pushbutton to highlight <i>PARAMETER WRITE</i> .	
Change the <i>PARAMETER WRITE</i> value to 0 by pressing the <i>NUMBER 0</i> pushbutton and then the <i>INPUT</i> pushbutton.	
Press the <i>RESET</i> pushbutton to reset ALARM 100.	

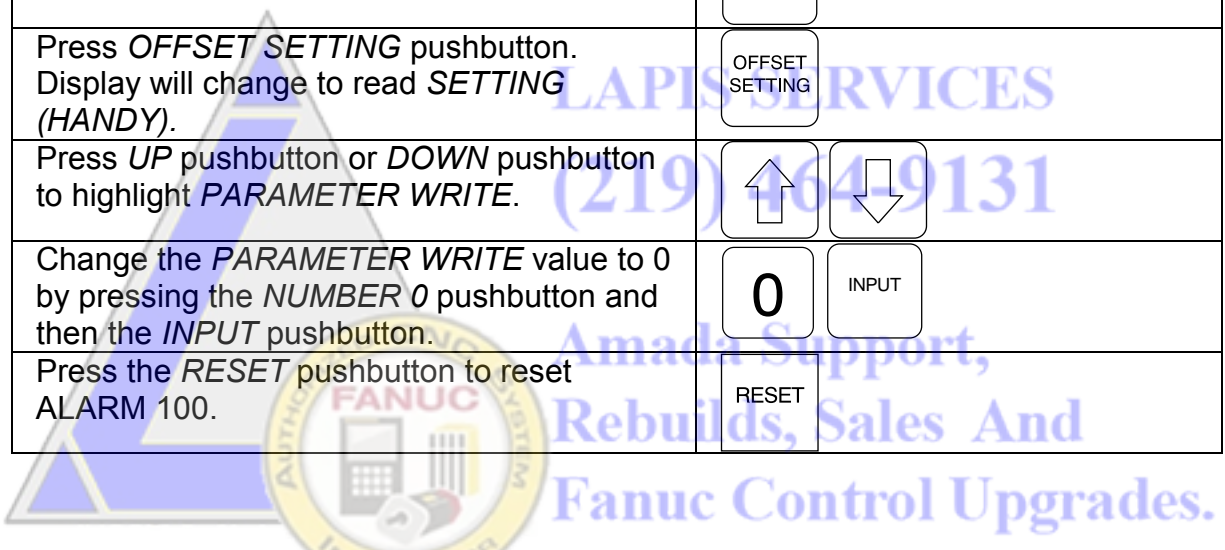

Configuring Windows9x/2000 HyperTerminal Program to Communicate with the Fanuc 18P Control.

This procedure is used to configure the Windows9x/2000 HyperTerminal program to communicate with the Fanuc 18P Control.

At the PC:

<p>In Windows9x/2000 start the <i>HyperTerminal</i> program.</p>	
<p>In the <i>Connection Description</i> window enter <i>FANUC18P</i> in the <u>N</u>ame field. Optionally choose an <u>I</u>con to represent this connection Select <i>OK</i> to continue.</p>	
<p>Configure the <i>Phone Number</i> window. Select <i>Connect</i> using: This displays the output connections available on the individual computer. Select the correct communication device for your computer. <i>Direct to Com 1</i> is the most common selection Select <i>OK</i> to continue.</p>	

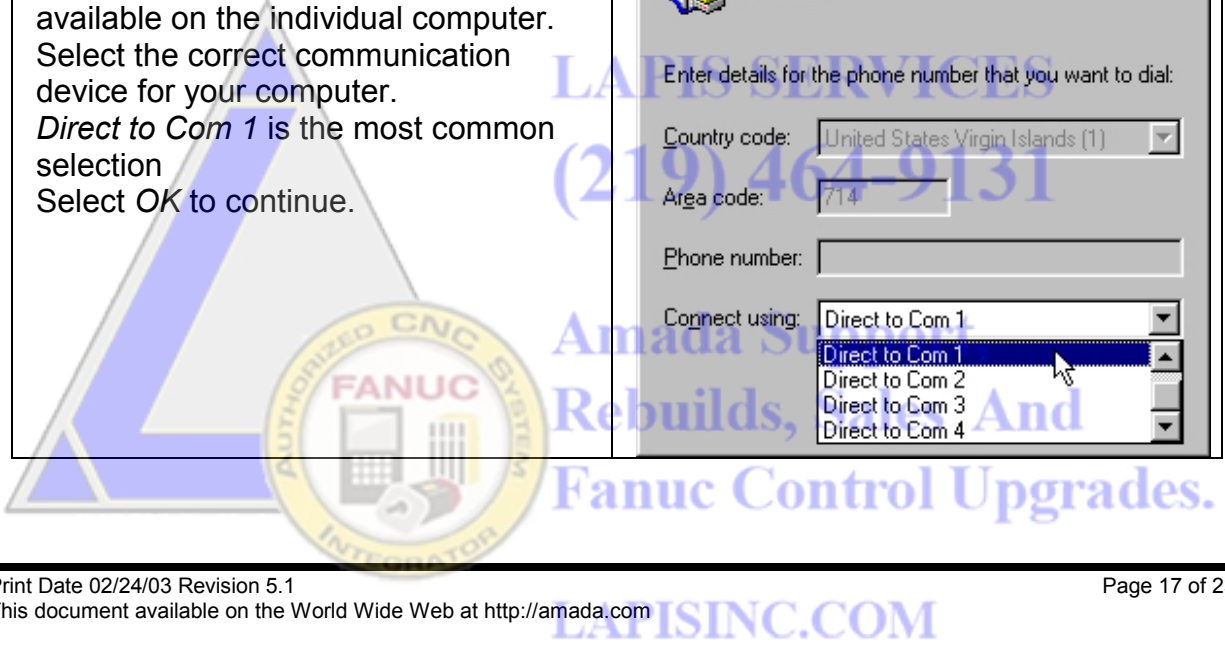

Configure the *Com Port Properties* window with the following settings:

- Bits per second 9600
 - Data Bits 7
 - Parity Even
 - Stop Bits 1
 - Flow Control Xon/Xoff
- Select **OK** to continue.

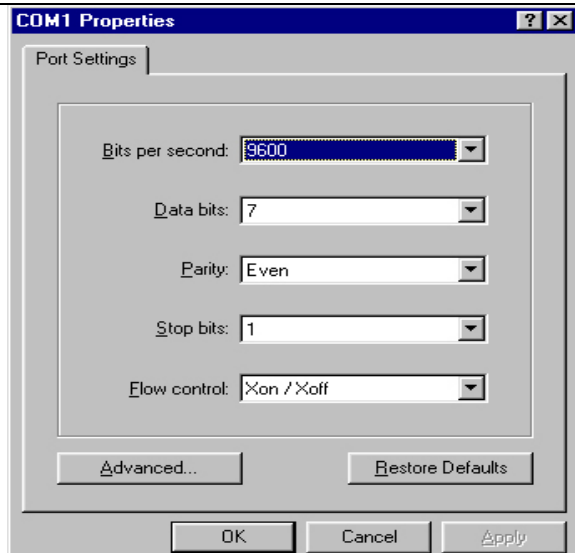

Configure the *FANUC18P HyperTerminal* window with the following settings"

- Select **File Properties Settings**
 - Function, arrow, and ctrl keys act as
 - Terminal keys
 - Window keys
 - Emulation VT100
 - Backscroll buffer lines: 500
 - Beep three time when connecting or disconnecting
- Select **Terminal Setup** to continue.

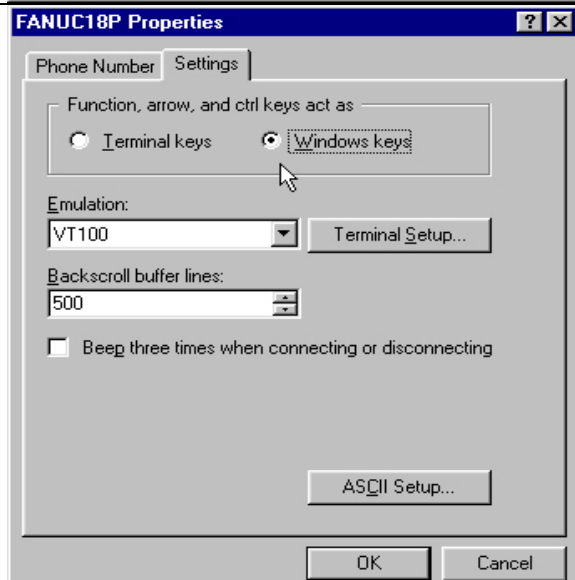

Configure the *Terminal Settings* window with the following values:

- Cursor
 - Block
 - Underline
 - Blink
 - Terminal Modes
 - Keypad application mode
 - Cursor Keypad mode
 - 132 column mode
 - Character set: ASCII
- Select **OK** to continue
- Select **ASCII Setup** to continue

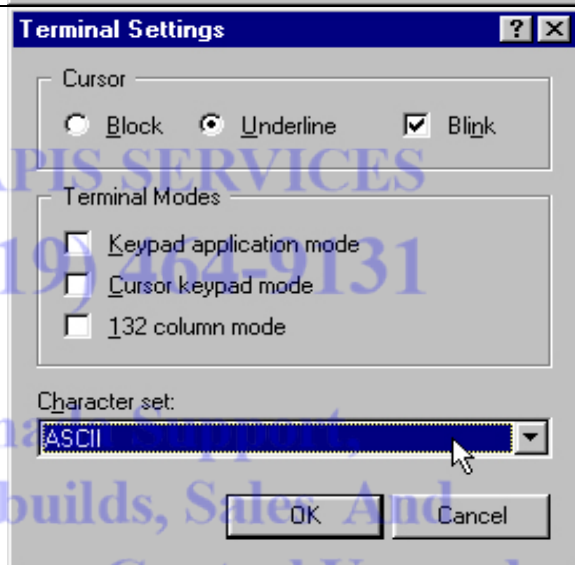

Configure the ASCII setup window with the following values:

ASCII Sending

- Send line ends with line feeds
- Echo typed characters locally
- Line Delay 5
- Character delay 0

ASCII Receiving

- Append line feeds to incoming line ends
- Force incoming data to 7-bit ASCII
- Wrap lines that exceed terminal width

Select OK to continue

Select OK to continue

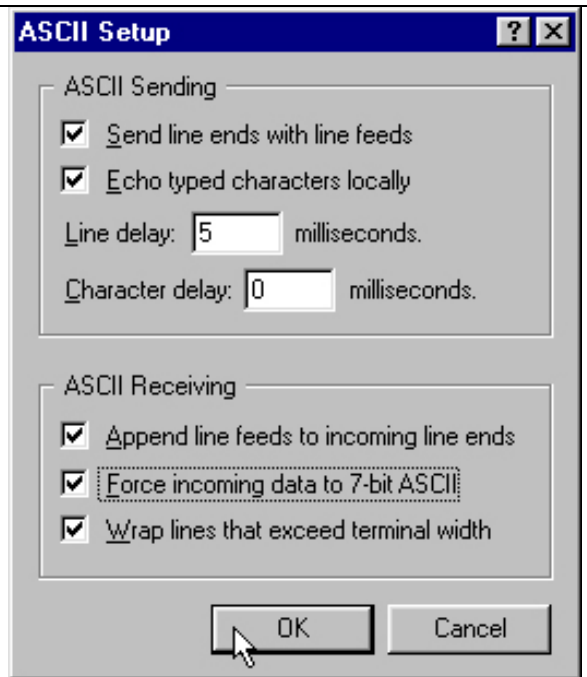

Save the Fanuc 18P Control HyperTerminal configuration settings by:

Select File

Select Save

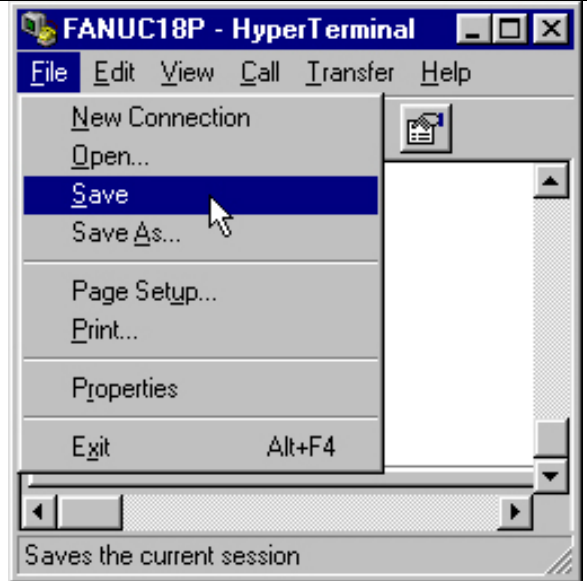

LAPIS SERVICES
(219) 464-9131

Amada Support,
Rebuilds, Sales And
Fanuc Control Upgrades.

Fanuc 18P Control Floppy Scheduler Operation











This procedure configures the Fanuc 18P Control to execute part programs contained on a floppy in the floppy drive automatically from the Fanuc 18P Control scheduler.

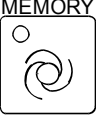





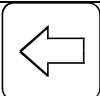

Prior to using this procedure the Fanuc 18P Control must be configured to communicate with the Internal Floppy Disk Reader.

When the last program in the scheduler is processed the machine will not return to the home position after the last hole is punched.

To ensure that the program returns to the home position after the last scheduled part has been produced is suggested that the final program entered into the scheduler be a DUMMY program consisting of only a G50 command.

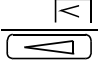
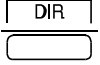
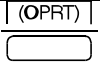
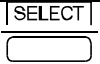
At the Fanuc 18P Control:

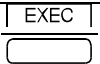
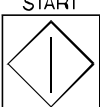
What you need to do:	What will happen:
 <p>Set REMOTO Switch to the left-hand position. The "Remoto" switch is located in the right side of the electrical cabinet, Behind the inner door.</p>	<p>No visible indication.</p>
 <p>Turn the FD EXTERNAL switch to the FD position.</p>	<p>No visible indication</p>
 <p>Press the MEMORY pushbutton</p>	<p>The lamp on the MEMORY mode pushbutton will illuminate.</p>
 <p>Press the PRGRM pushbutton.</p>	<p>The display will change to show: The last active program.</p>
 <p>Press the DIR softkey.</p>	<p>The display will change to show: The DIR softkey</p>
 <p>Press the FL SDL softkey.</p>	<p>The display will change to show: The FL SDL softkey.</p>
 <p>Press the SCHEDUL softkey.</p>	<p>The display will change to show: FILE DIRECTORY.</p>
 <p>Press the OPRT softkey.</p>	<p>The display will change to show: The last used schedule information.</p>
 <p>Press the CLEAR softkey.</p>	<p>The display will change to show: The CLEAR softkey.</p>
 <p>Press the EXEC softkey.</p>	<p>The display will change to show: The EXEC softkey.</p>
 <p>Press the EXEC softkey.</p>	<p>The display will change to show:</p>

	The existing schedule will clear The INPUT softkey.
Press the     pushbuttons and  softkey to set FILE NO (file number of the file not the program number), and REQ REP (required repetitions) within the scheduler page.	As the information is INPUT the scheduler display will change to show the INPUT information.
Press the  softkey	The display will change to show: The DIR softkey.
Press the  softkey	The display will change to show: FILE DIRECTORY
Press the  softkey.	The display will change to show: The SELECT softkey.
Press the  softkey.	The display will change to show: The F SET softkey.
Press the  pushbutton to select the schedule file.	The display will change to show: >0
Press the  softkey.	The display will change to show: SELECT FILE NO.= 0
Press the  softkey.	The display will change to show: FILE DIRECTORY CURRENT SELECTED; SCHEDULE
Press the  pushbutton.	The Fanuc 18P Control will process the first part program entered in the scheduler. The processing of programs will continue until the last line of the last program in the scheduler is processed. The Fanuc 18P Control will then display an ERROR 5010.
Press the  pushbutton.	The display will change to show: The ERROR 5010 will be removed.

If the last program of the scheduler was not the DUMMY program suggested at the beginning of this program it will be necessary to reset the origin of the machine to continue processing the next programs.

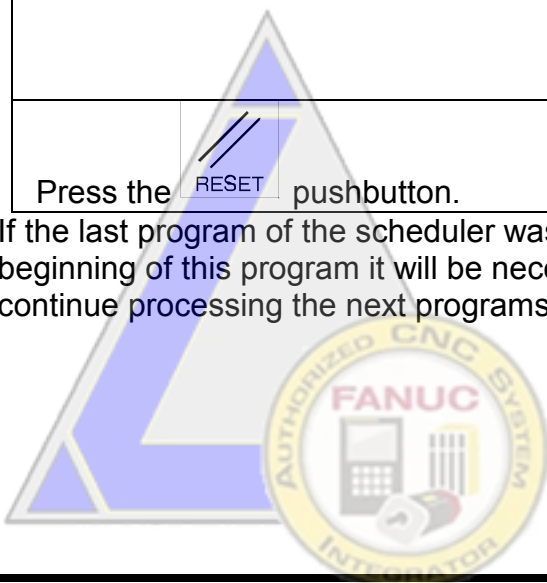

LAPIS SERVICES
(219) 464-9131

Amada Support,
Rebuilds, Sales And
Fanuc Control Upgrades.

Communications Block Diagram

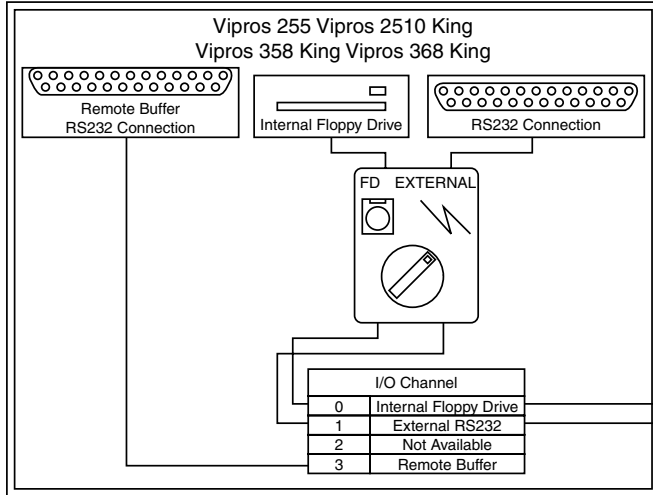

Configuration for Internal Floppy Drive	Parameter Number	Setting							
		7	6	5	4	3	2	1	0
100	ENS	IOP	ND3		NCR		CTV		
	0	0	0	0	0	1	0	0	0
101	NFD					ASI			SB2
	1	0	0	0	0	1	0	0	1
Device Number	102	3							
Baud Rate	103	10 (4800)							

Configuration for Amada AMP1E, Windows 3.1 Terminal, Windows95 HyperTerminal	Parameter Number	Setting							
		7	6	5	4	3	2	1	0
100	ENS	IOP	ND3		NCR		CTV		
	0	0	0	0	0	1	0	0	0
111	NFD					ASI			SB2
	1	0	0	0	0	0	0	0	1
Device Number	112	0							
Baud Rate	113	11 (9600)							

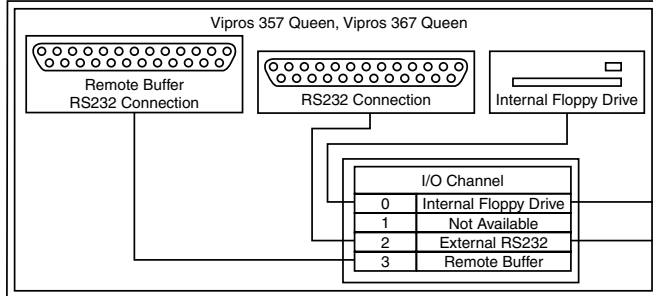

Configuration for Metal Soft Machine Talk	Parameter Number	Setting							
		7	6	5	4	3	2	1	0
100	ENS	IOP	ND3		NCR		CTV		
	0	0	1	0	0	0	0	0	0
111	NFD					ASI			SB2
	1	0	0	0	0	0	0	0	1
Device Number	112	0							
Baud Rate	113	8 (1200)							

Configuration for Other	Parameter Number	Setting							
		7	6	5	4	3	2	1	0
100	ENS	IOP	ND3		NCR		CTV		
111	NFD					ASI			SB2
Device Number	112	0							
Baud Rate	113								

Control Baud Rate Settings:

Desired Baud rate:	Set appropriate parameter to:
1200	8
2400	9
4800	10
9600	11

LAPIS SERVICES
(219) 464-9131

**Amada Support,
Rebuilds, Sales And
Fanuc Control Upgrades.**

Cables

Amada standard RS232 cable configuration:

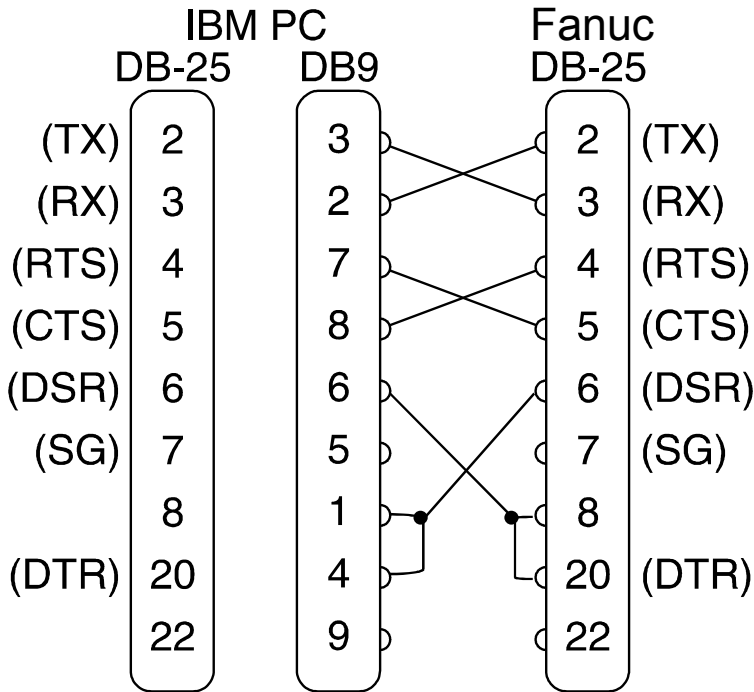

MetalSoft configuration:

